

User Manual

VECTOR LITTLE BEAVER 2.0 ULTRASONIC SCALER (25/30K)

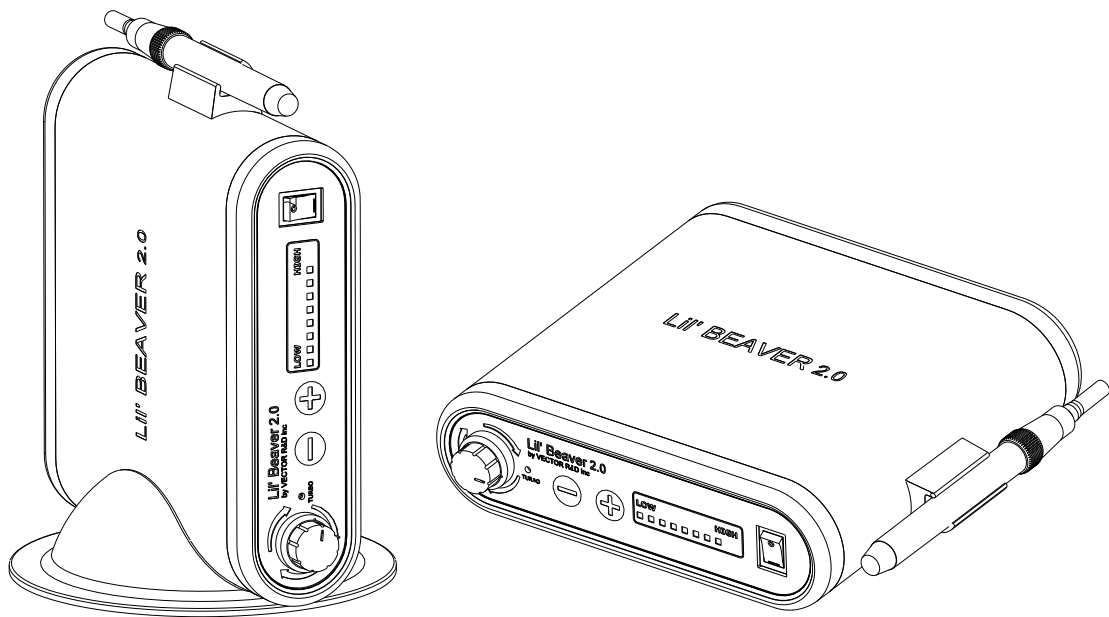

Instruction For Use

**VECTOR R & D INC.
6824 19TH ST#230 UNIVERSITY PLACE
WA 98466 USA Web: www.vectorusa.net**

S-19-01-1214-UV101 V1.3

Table Of Contents

Section Number	Section Title Description of Contents	Page Number
1	Precautions.....	3
	1.1 Precautions for All Systems	
	1.2 Precautions for Ultrasonic Prophylaxis Procedure	
2	Introduction.....	4
3	Application.....	4
4	Specification.....	5
5	Contraindications and Warnings.....	6
	5.1 Contraindications	
	5.2 Warnings	
6	Infection Control.....	6
	6.1 General Infection Control Recommendations	
	6.2 Water Supply Recommendations	
7	Installation Instructions.....	7
	7.1 General Information	
	7.2 Water Line Requirements	
	7.3 Electrical Requirements	
	7.4 Unpacking the System	
	7.5 System Installation	
	7.6 Vertical Installation	
	7.7 Rear Panel Controls / Power Connection	
	7.8 Water Supply Line Connection	
8	Little Beaver 2.0 Ultrasonic Scaler Description.....	8-9
	8.1 System Controls	
	8.2 Handpiece Holder	
	8.3 Ultrasonic Insert, Handpiece Sleeve Assembly/Disassembly	
	8.4 Foot Switch Controls and Operation	
9	Accessories.....	10
10	Techniques For Use.....	10
	10.1 Patient Positioning	
	10.2 Performing Ultrasonic Scaling Procedures	
	10.3 Patient Comfort Considerations	
11	System Maintenance And Care.....	11
12	Trouble shooting.....	12
13	Disposable of Unit.....	13
14	Disclaimer.....	13
15	WARRANTY.....	14
16	Additional Symbols.....	15

Section 1: Precautions

Prior to installation and start-up of the ultrasonic scaler, carefully read the instructions provided herein!

1.1 Precautions for All Systems

 Do not place the ultrasonic scaler on or next to a radiator or other heat source. Excessive heat may damage the ultrasonic scaler's electronics. Place the ultrasonic scaler where air is free to circulate on all sides and beneath it. Do not cover vents on rear panel.

 The ultrasonic scaler which can be carried vertical or plate is portable, but must be handled with care when moving.

 Equipment flushing and dental water supply system maintenance are strongly recommended. See Section 11: System Maintenance And Care.

 Close the water shut-off valve in the dental water supply system every night before leaving the office.

 The use of an in-line water filter is recommended.

 Never operate the ultrasonic scaler without water flowing through the handpiece.

 Grounding reliability can only be achieved when the equipment is connected to an equivalent receptacle marked Hospital Only or Hospital Grade.

1.2 Precautions for Ultrasonic Prophylaxis Procedures

- Like a toothbrush, ultrasonic inserts "wear out" with use. Inserts with just 2 mm of wear lose about 50% of their scaling efficiency. In general, it is recommended that ultrasonic inserts be discarded and replaced after one year of use to maintain optimal efficiency and avoid breakage.
- If excessive wear is noted, or the insert has been bent, reshaped or otherwise damaged, discard the insert immediately.
- Ultrasonic insert tips that have been bent, damaged, or reshaped are susceptible to in-use breakage and should be discarded and replaced immediately.
- Retract the lips, cheeks and tongue to prevent contact with the insert tip whenever it is placed in the patient's mouth.

Section 2: Introduction

2.1 Function:

The Little Beaver 2.0 Ultrasonic Scaler is designed for use in prophylaxis treatments periodontia, and other areas of operative dentistry. When used in prophylaxis treatment, the unit operates with a fine warm water spray, requiring little of the physical exertion necessary with hand instruments. It easily and effectively removes stubborn calculus and stains both supragingivally and subgingivally, leaving crown and root surfaces clean and smooth.

2.1 Conformance to Standards:

The Vector R & D Inc. Little Beaver 2.0 Ultrasonic Scaler conforms to IEC60601-1-2:2007 and IEC60601-1-1:2005.

The device is CE marked corresponding to European Medical Device Directive (93/42/EEC)

2.2 Supplies and Replacement Parts

Contact your local Vector R & D Inc. dealer to order supplies or replacement parts. There are no serviceable parts included in this device. Please contact your dealer to acquire all repairing service and technique supports.

CAUTION: EQUIPMENT NOT SUITABLE FOR USE IN THE PRESENCE OF FLAMMABLE ANESTHETIC MIXTURE WITH AIR OR WITH NITROUS OXIDE.

CAUTION: U.S FEDERAL LAW RESTRICTS THIS DEVICE TO SALE BY OR ON THE ORDER OF A DENTAL PROFESSIONAL.

Section 3: Application

The Ultrasonic Scaler procedures

- All general supra and subgingival scaling applications.
- Periodontal debridement for all types of periodontal diseases.
- Endodontic procedures.

Section 4: Specifications

Vector R & D Inc. Little Beaver 2.0 Ultrasonic

Scaler is multi-voltage 110V/230V unit.

4.1 Electric Voltage:

VOLTAGE:	CURRENT
100VAC 50/60Hz	1.0 A (MAX)
110VAC 50/60Hz	1.0 A (MAX)
230VAC 50/60Hz	0.6 A (MAX)
WATTAGE:	MAX.85 W
WATER PRESSURE:	20-40 psi

4.2 Dimension:

HEIGHT :	6.5 CM
WIDTH :	23.0 CM
DEPTH :	22.0 CM
WEIGHT :	2.1 KG

4.3 Operation Environment:

AMBIENT TEMPERATURE	: +10°C - +40°C
RELATIVE HUMIDITY	: 30% - 75%
ATMOSPHERIC PRESSURE	: 700 hPa - 1060hPa

4.4 Transportation And Storage Environment:

AMBIENT TEMPERATURE	: -10 °C ~+70 °C
RELATIVE HUMIDITY	: 10%~90%
ATMOSPHERIC PRESSURE	: 500 hPa ~1060 hPa

Section 5: Contraindications and Warnings

5.1 Contraindications

- Ultrasonic Systems should not be used for restorative dental procedures involving the condensation of amalgam.
- This device is designed to work with all Cavitron® (remark) insert with 25Khz or 30Khz frequency automatically. For optimum performance please use only qualified inserts supplied by Cavitron® or Rolence®.
- Do not use this device if the patient or operator is wearing a pacemaker.

Remark: Cavitron® is a registered trademark of Dentsply® International, Inc

5.2 Warnings

- Persons who are fitted with cardiac pacemakers, defibrillators and other active implanted medical devices, have been cautioned that some types of electronic equipment might interfere with the operation of the device. We recommend that the handpiece and tubing be kept at least 6 to 9 inches (15 to 23 cm) away from any device and their leads during use.
- During using the unit, make sure that water is flowing continuously. If the handpiece overheats please check the water supply, and stop using the unit for a while.

Section 6: Infection Control

6.1 General Infection Control

Recommendations

- As with all dental procedures, the use of standard personal protection equipment (i.e., wearing a face mask, eyewear, or face shield, gloves and protective gown) is recommended.
- For maximal operator and patient safety, carefully follow section 11 system maintenance and care information detailed in the operating instruction accompanying your ultrasonic scaler.
- As with high speed handpieces, and other dental devices, the combination of water and ultrasonic vibration from your ELITEDENT® Ultrasonic Scaler will create aerosols. With proper technique, much of the aerosol dispersion can be effectively controlled and minimized. Please carefully follow the procedural guidelines in this manual regarding the use of your ultrasonic scaler.
- Always flush your ELITEDENT® Ultrasonic Scaler with highest flow before treatment. Refer to more information in section 10.
- Clean and disinfect the handpiece sleeve between patients. The handpiece sleeve can be autoclaved

up to 135°C for at least 3 minutes.

Sterilizing:

1. Place handpiece sleeve and pouched ultrasonic insert into a steam autoclave. After warm-up is completed, operate at a sterilizing temperature and pressure of 273° F/31 psi (134°C/216 kPa) for 12 minutes, followed by a 20-30 minute drying time.
2. To maintain sterility, the insert should remain in the sealed pouch until it is ready for use.

DO NOT USE Cold sterilization solution.

6.2 Water Supply Recommendations

- It is highly recommended that all dental water supply systems should conform to applicable CDC (Centers for Disease Control and Prevention) and ADA (American Dental Association) standards, and that all recommendations be followed in terms of flushing, chemical flushing, and general infection control procedures. See sections 6.1 and 11.

Section 7: Installation Instructions

7.1 General Information

If installation of your Little Beaver 2.0 ultrasonic scaler is performed by someone other than trained Vector R & D Inc. distributor personnel, care should be taken to observe the following requirements and recommendations.

7.2 Water Line Requirements

- The System's water supply line is factory installed. Do not disconnect from the ultrasonic scaler.
- Incoming water supply line pressure to the ultrasonic scaler must be 25 psi (172 kPa minimum) to 40 psi (276 kPa) maximum. If your dental water system's supply line pressure is above 60 psi, install a water pressure regulator on the water supply line to your ultrasonic scaler.
- A manual shut-off valve on the dental water system supply line should be used so that the water can be completely shut-off when the office is unoccupied.
- A filter in the dental water system supply line is recommended so that any particles in the water supply will be trapped before reaching the ultrasonic scaler.
- After the above installations are completed on the dental water supply system, the dental office water line should be thoroughly flushed prior to connection to the System.
- After flushing system verify there are no leaks.

7.3 Electrical Requirements

Refer to Section 3: Specifications.

7.4 Unpacking the System

Carefully unpack your Little Beaver 2.0 ultrasonic scaler and verify that all components and accessories are included:

1. Little Beaver 2.0 Ultrasonic scaler main unit with factory installed water supply line and handpiece assembly with tubing.
2. Detachable AC Power Cord.
3. Foot Control Switch.

4. User Direction Manual.
5. Ultrasonic Inserts (Optional).

7.5 System Installation

- The Little Beaver 2.0 Ultrasonic Scaler is designed for both horizontal and vertical placement on a level surface. Refer to section 7.6 for more information of vertical installation.
- Be sure unit is stable and resting on four feet.
- Placing unit in direct sunlight may discolor plastic housing.

7.6 Vertical Installation

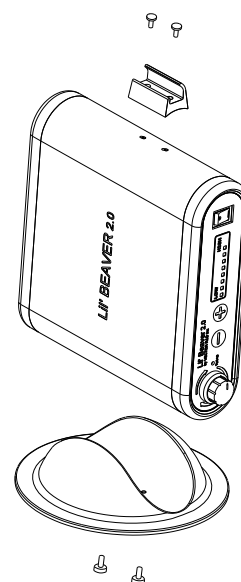

7.7 Rear Panel Controls / Power Connection

- The ON/OFF Control Switch and power indicator is located on the Front Panel of the Little Beaver 2.0 Ultrasonic Scaler. (See Section 8.1)
- Verify the ON/OFF Control Switch located on the front panel of the Little Beaver 2.0 ultrasonic scaler is in the OFF position before proceeding.
- Plug the detachable AC Cord into the back of the ultrasonic scaler and into an approved outlet.

7.8 Water Supply Line Connection

Connect the free end of the ultrasonic scaler's water supply line to the dental water supply line. Inspect all connections to make certain there are no leaks.

Section 8: Little Beaver 2.0 Ultrasonic Scaler Description

8.1 System Controls – Rear Panel

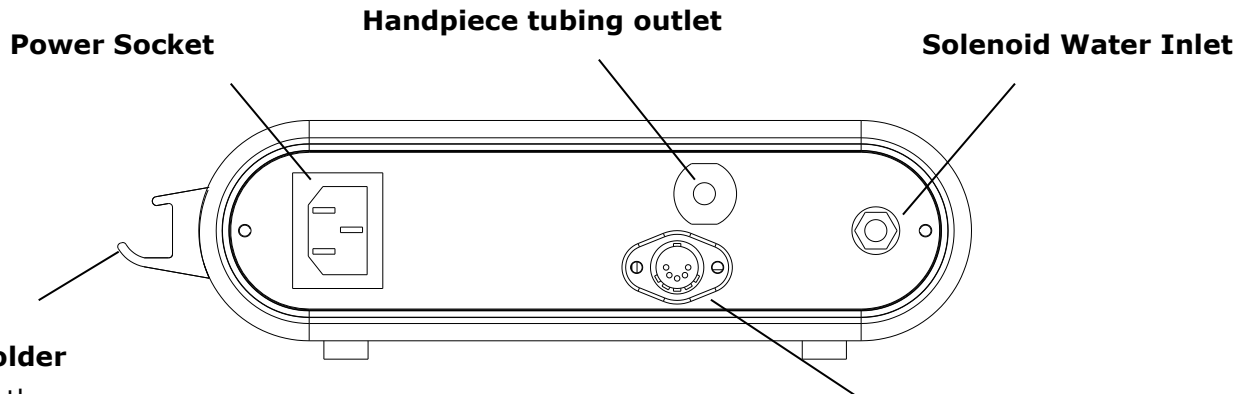

Handpiece Holder
Securely holds the Handpiece when system is not being used.

Foot Switch Connector
Connect foot switch here, ensure it is firmly seated.

Front Panel

Turbo Indicator Light
Illuminates when foot switch is deeply pressed, and it is functioning in "Turbo" mode.

Intensity Display
Indicates the power level, total 8 LEDs display.

Power Switch / AC Power Indicator Light
Illuminates when POWER ON/OFF control switch is on.

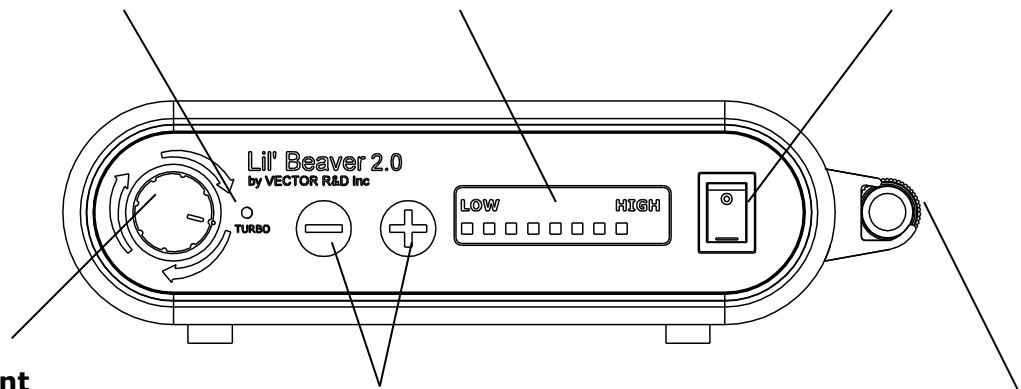

Water Flow Adjustment
Turn knob to select Water Flow level for operation. Clockwise increases water flow, while counterclockwise decreases water flow.
The rate of flow through the Handpiece determines the temperature of the water flow. Lower flow rate produces warmer temperature; higher flow rate produces cooler temperature.

Intensity Control
Increase or decrease power level for operation: "+" increases power, "-" decreases power.

Handpiece
Operates 25Khz or 30Khz Ultrasonic inserts and transmits power and water flow from the scaler to the insert.

8.2 Handpiece Holder

When your ultrasonic scaler is set up horizontal, you can choose to installed handpiece holder to the left side of the main unit if you are a left-handed user.



8.3 Handpiece Assembly / Handpiece Sleeve

The ultrasonic scaler is multi-frequency unit compatible with all Cavitron® 25Khz or 30 Khz inserts. The system will automatically detect the insert frequency, no need to switch any button.

For more oral hygiene care, the handpiece sleeve can be dismantled and autoclaved. See below:

Handpiece Sleeve

Enable to dismantle and autoclave

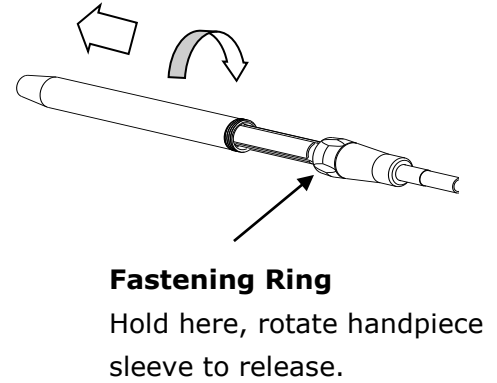
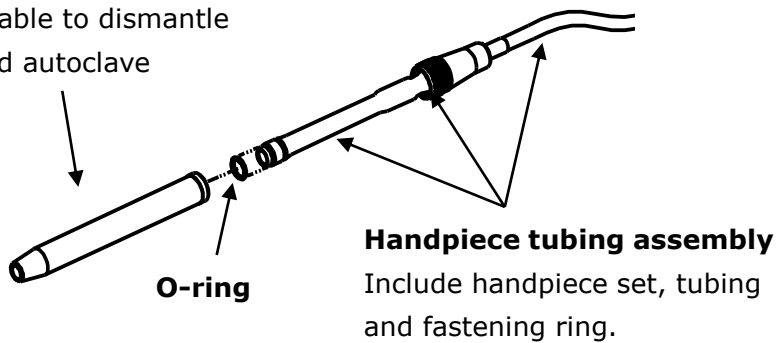

To take off the handpiece sleeve, please hold the fastening ring, and rotate the sleeve counterclockwise from handpiece tubing assembly. **Note: Avoid rotate or twist the handpiece tubing.**

8.4 Foot Switch Controls and Operation

The Foot Switch is a two-position momentary switch, which activates both Ultrasonic energy and water flow at insert tip.

<p>Foot Switch Released... Both ultrasonic activation and irrigating flow stop.</p>	<p>Foot Switch Depressed Half Way (1st position) The ultrasonic insert tip is activated and irrigating water flow under normal function.</p>	<p>Foot Switch fully depressed (2nd position) This activates the "Turbo" mode increasing extra power.</p>

Section 9: Accessories

1. Ultrasonic insert (optional)
2. AC Power Cord Set
3. Foot control switch
4. Water tubing with quick connector

Section 10: Techniques For Use

10.1 Patient Positioning

- For optimal access to both the upper and lower arches, the backrest of the chair should be adjusted to a 45° degree angle. This assures patient comfort and Clinician visibility.
- Have the patient turn his/her head to the right or left. Also position chin up or down depending upon the quadrant and surface being treated. Evacuate irrigate using either a saliva ejector or High Volume Evacuator (HVE).

10.2 Performing Ultrasonic Scaling

Procedures

- Note: Refer to the Infection Control Information Booklet supplied with your system for general procedures to be followed at the beginning of each day and between patients.
- The edges of ultrasonic inserts are intentionally rounded so there is little danger of tissue laceration with proper ultrasonic Scaling technique. Whenever the insert tip is placed in the patient's Mouth, the lips, cheek and tongue should be retracted to prevent Accidental prolonged contact with the activated tip.
- Hold the empty Handpiece in an upright position. Activate the Foot Control until fluid exits.
- Lubricate the rubber O-ring on the insert with water before placing it into the handpiece. Fully seat insert with a gentle push-twist motion. DO NOT FORCE IT INTO PLACE.
- Activate the System. Hold the handpiece over a sink or drain. Check spray temperature to verify fluid is reaching the working end of the insert tip. Adjust the water cooler irrigate. Control knob to ensure adequate flow for the selected Power

setting. Greater flow settings provide cooler irrigation.

- It may be necessary to adjust water flow larger under "Turbo" mode (Foot Control fully depressed) so adequate fluid will be available to cool tip and tooth interface.
- In general, it is suggested a "feather-light-touch" be used both supra and subgingivally. The motion of the activated tip and acoustic effects of the irrigating fluid, in most cases, is adequate to remove even the most tenacious calculus.
- Periodically check the ultrasonic insert for wear with the Insert Efficiency Indicator.
- The use of a saliva ejector or High Volume Evacuator (HVE) is recommended during all procedures.
- Set the System's Power Adjustment knob to the lowest power setting for the application and the selected insert.
- If water leakage found in handpiece, replace sleeve or o-ring on handpiece cable assembly to eliminate.

10.3 Patient Comfort Considerations

Reasons for sensitivity

- Incorrect tip placement. Point should be directed away from root surfaces.
- Not keeping tip in motion on tooth. Do not allow the insert to remain in a static position on any one area of the tooth. Change the insert's path of motion.
- Applying pressure. Use extremely light grasp and pressure, especially on exposed cementum.
- If sensitivity persists, decrease power setting and/or move from the sensitive tooth to another and then return.

Section 11: System Maintenance and Care

Daily Maintenance

It is recommended that you perform the following maintenance procedures to help minimize bio-film formation in the water path of your Little Beaver 2.0 ultrasonic scaler which could affect the water flow to the ultrasonic insert, and scaling performance.

Start-Up Procedures at the beginning of the day:

1. Open the manual shut-off valve on the dental office water supply system.
2. Turn the System ON using the Power ON/OFF switch. (see illustration on page 7) Verify the Power Indicator Light is on.
3. Set the Power Control knob to minimum setting.
4. Set the Water Control knob to maximum.
5. Hold the Handpiece (without an insert installed) upright over a sink or drain. Activate the Foot Control and flush the water line for at least 2 minutes.
6. Place a sterilized insert into the Handpiece and set the water control knob to your preferred operating position.

Between Patients:

1. Remove ultrasonic insert and handpiece sleeve used, clean and sterilize.
2. Clean and disinfect the surfaces of the cabinet, Power Cord, Handpiece cable assembly*, control knobs, Foot Control and cable assembly by applying an approved non-immersion type disinfectant solution* carefully following the instructions provided by the disinfectant solution manufacturer. To clean system, generously spray disinfectant solution on a clean towel and wipe all surfaces. Discard used towel. To disinfect system, generously spray disinfectant on a clean towel and wipe all surfaces. Allow disinfectant solution to air dry. Do not spray disinfectant solution directly on the ultrasonic scaler.
3. Place a sterilized handpiece sleeve. Set power to

minimum. Hold the handpiece over a sink or drain and flush the water line at maximum water flow for 30 seconds.

4. When ready, place a sterilized insert into the handpiece.
5. Please consider use a FDA approved sheath to for the cable and entire handpiece or at least to cover the handpiece from the fastening ring to cable when sleeve is sterilized between patients.

Shut-Down Procedures at the end of the day:

2. Remove ultrasonic insert and handpiece sleeve used, clean and sterilize.
3. Turn the System OFF.
4. Clean and disinfect the surfaces of the cabinet, Power Cord, Handpiece cable assembly, control knobs, Foot Control cable assembly by applying an approved non-immersion type disinfectant solution* carefully following the instructions provided by the disinfectant solution manufacturer. To clean system, generously spray disinfectant solution on a dean towel and wipe all surfaces. Discard used towel. To disinfect system, generously spray disinfectant on a clean towel and wipe all surfaces. Allow disinfectant solution to air dry. Do not spray disinfectant solution directly on the ultrasonic scaler.
5. Close the manual shut-off valve on the dental water supply system.

***Note:** Those Water-based disinfection solutions are preferred, due some alcohol-based disinfectant solutions may be harmful and may discolor plastic materials.

***Note:** The electric wire winding covered by heat shrinkage tube which protected by handpiece sleeve is very sensitive to the disinfectant solution and water. After the disinfection, wipe surface of shrinkage tube with a slightly damp cloth and dry thoroughly before use.

Section12: Trouble shooting

Although service and repair of the Little Beaver 2.0 Ultrasonic Scaler should be performed by VECTOR R & D INC. dealer personnel, the following are some basic trouble shooting procedures that will help avoid unnecessary service calls. Generally, check all lines and connections to and from the System, a loose plug or connection will often create problems. Check the settings on the System's knobs.

12.1 Troubleshooting Guide

Problem: System will not operate: (Power Indicator Light is not lit.)

1. Check that the Power switch is in the ON position, and that the detachable Power Cord is fully seated in the receptacle on back of System.
2. Check that the System's three-prong plug is fully seated in an appropriate AC receptacle, and that AC current is present.

(Power Indicator Light is lit.)

1. Check that the Foot Control Connector is fully seated in the Foot Control Receptacle on the back of the System.

System operates:

(No water flow to insert tip.)

1. Assure that water control is properly adjusted.
2. Check that water supply control valve(s) (dental office water supply) are open.

(Insert stops vibrating)

1. Deactivate foot control.
2. Verify insert is in good condition.
3. Depress foot control to try again.

Section 13: Disposal of Unit

- Keep original packaging until the Little Beaver 2.0 Ultrasonic Scaler is to be disposed of permanently. You can use it for shipping or storing your Little Beaver 2.0 Ultrasonic Scaler at any time.
- Dispose of the Little Beaver 2.0 Ultrasonic Scaler in accordance with local and national laws.

Section 14: Disclaimer

VECTOR R & D INC considers itself responsible for the effects on safety, reliability and performance of this product only if:

- Assembly operations, extensions, re-adjustments, modifications or repairs are carried out by persons, authorized by VECTOR R & D INC.
- The electrical installation of the relevant room complies with the requirements.
- The equipment is used in accordance with these instructions for use.

Section 15: Warranty

15.1 Malfunction

Vector R & D Inc. hereby warrants that for a period of one year from the delivery date, this device shall be free from defects in material and workmanship. In case the machine is found malfunctioned under normal use, Vector R & D Inc. will offer service of free maintenance and parts for replacement.

15.2 Repair













Repairs must be only carried out by an authorized Vector R & D Inc. engineer/dealer. If repairs during warranty period are not carried out by an authorized engineer/dealer, warranty will expire immediately.

15.3 Warranty Exception

The warranty stated herein is the sole warranty applicable to Vector R & D Inc. products. Vector R & D Inc. expressly disclaims the liability for warranty even within warranty period, if

- (1) Damages caused by natural disaster.
- (2) Operator's fault or wrong operation.
- (3) Application use other than curing light-cured material purpose.
- (4) A malfunction or damage caused by repair, adjustment, modification which is not carried out by Vector R & D Inc. authorized technicians/dealers.
- (5) A malfunction caused by abnormal power source or voltage.
- (6) It is a consumption part.

Section 16: Additional Symbols

	Caution, Consult accompanying Documents
	Read usage instructions
	Alternating Current
	Manufacturer
	Date of manufacture
	Catalogue number
	Type BF Applied Part; Type BF Equipment - Protection against electric shock
	Equipment class: Class II (IEC601-1) - double insulated
	The equipment complies with the requirements in the Medical Device Directive 93/42/EEC.
	Icon to identify electric and electronic devices. The unit must be collected and disposed of separately.
	Power off
	Power on

